

Chess Board by Marc Kirschenbaum (NY)

©1996

Complex
A 25" square makes a 5" board

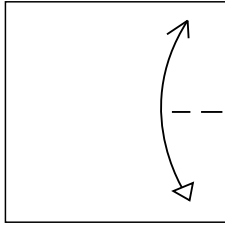

1. Pinch in half.

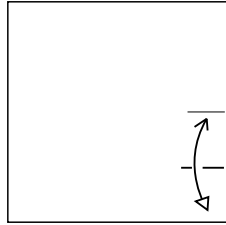

2. Pinch again.

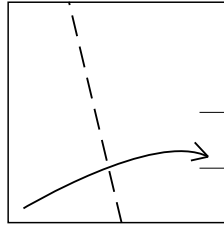

3. Valley corner to crease.

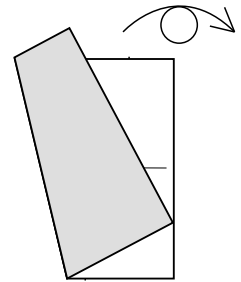

4. Turn over.

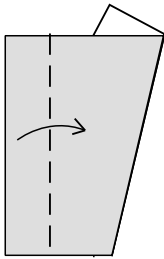

5. Valley to intersection of raw edges.

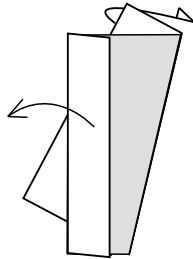

6. Unfold.

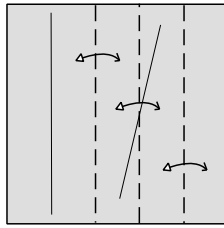

7. Precrease section into fourths.

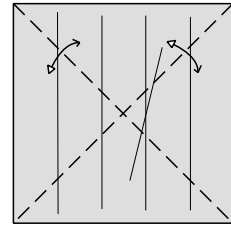

8. Precrease along diagonals.

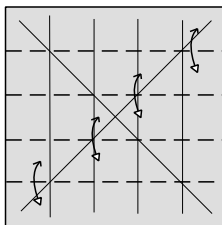

9. Precrease, using the intersections of diagonals as a guide.

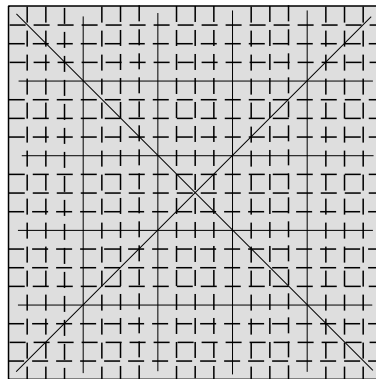

10. Divide each section further into fourths.

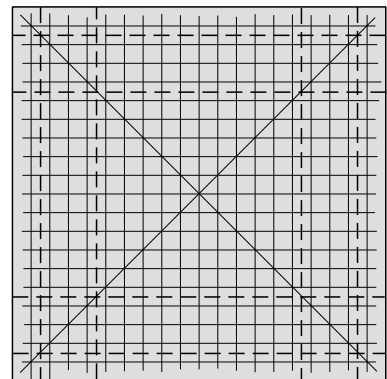

11. Add additional preceases (divide the indicated columns and rows in half). Rotate model.

1/4

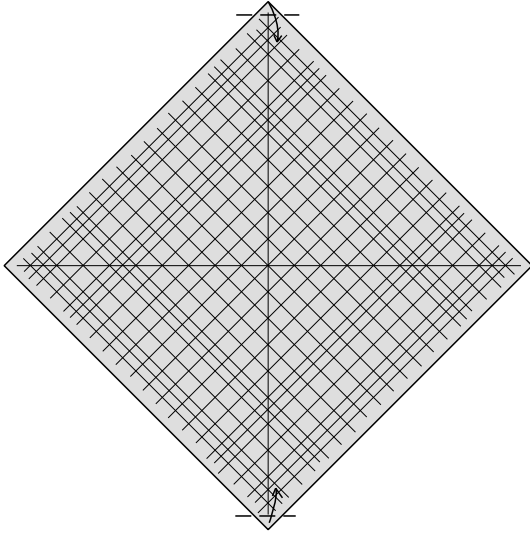

12. Valley the corners in (one unit).

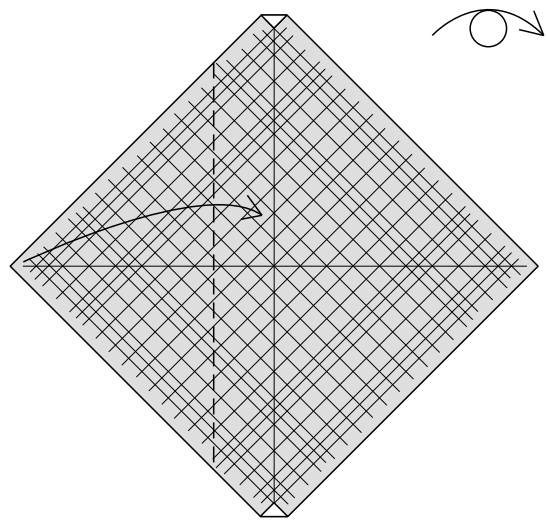

13. Valley inwards. This fold is touching the folds made in step 11. Turn over.

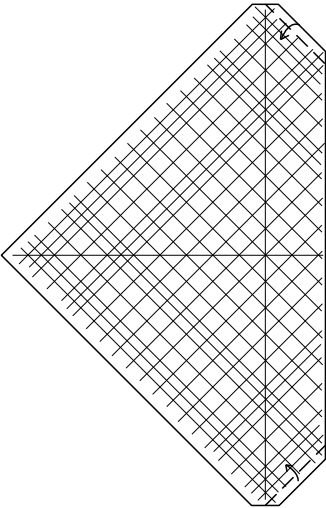

14. Valley the edges to the nearest crease.

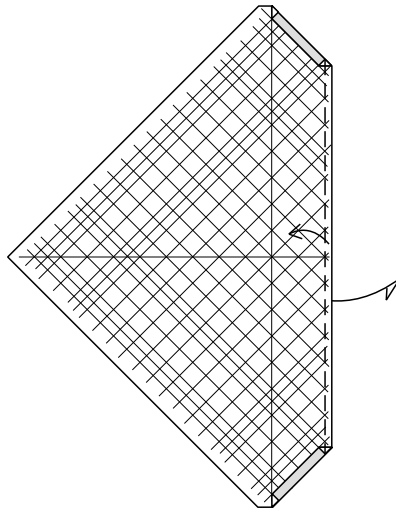

15. Valley, swinging the flap from behind to the forefront.

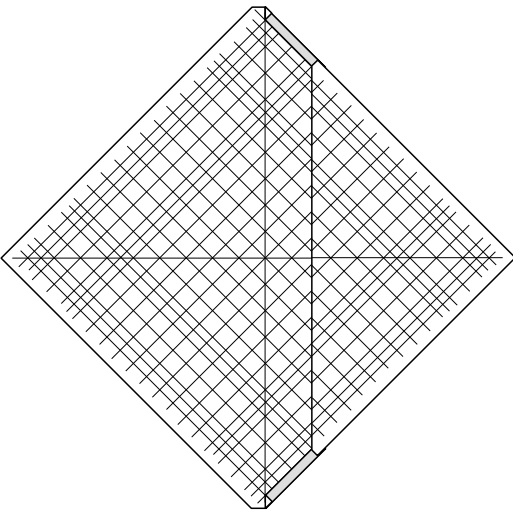

16. Turn over.

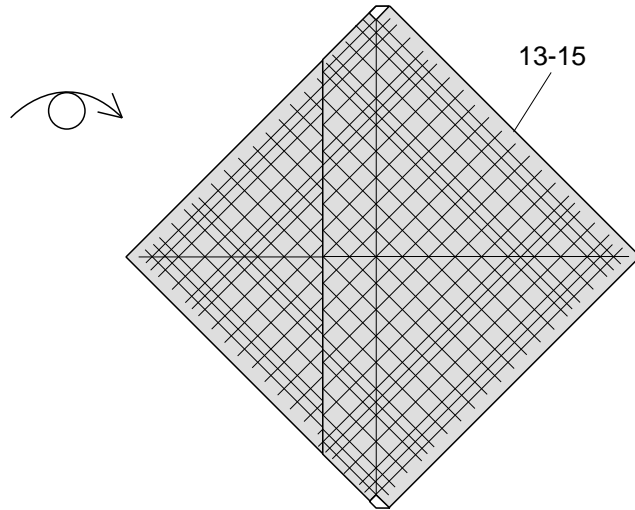

17. Repeat steps 13-15 on the other side.

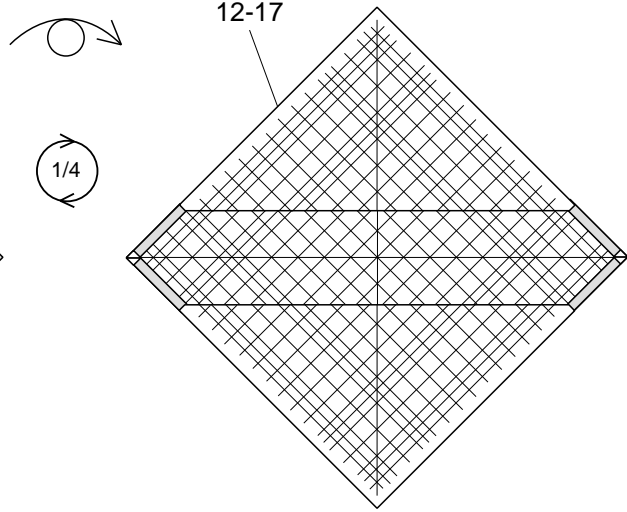
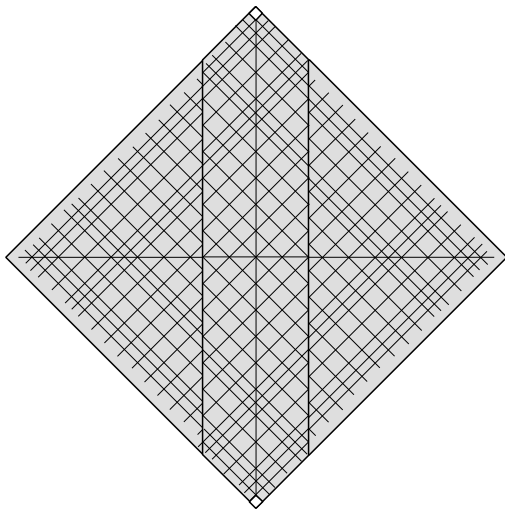

18. Turn over and rotate.

19. Repeat steps 12-17.

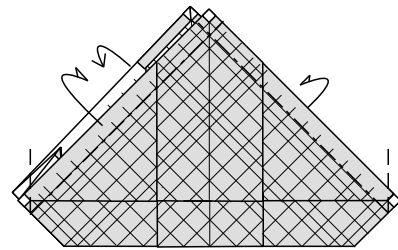
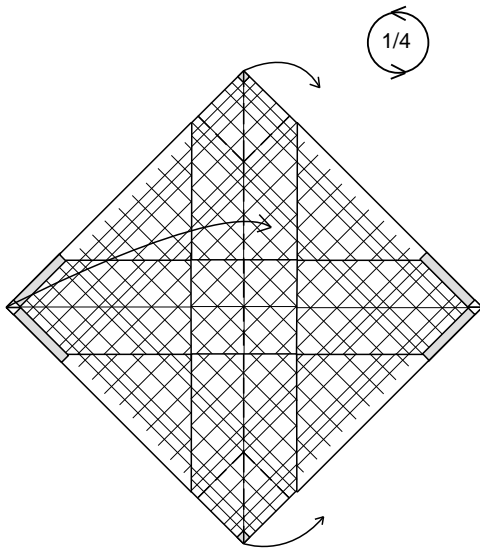

20. Valley in half while incorporating reverse folds. Rotate model.

21. Swivel in sides. The layers will overlap at the top corners.

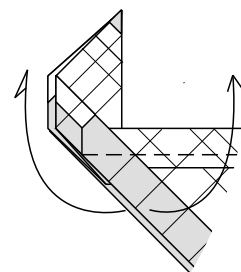
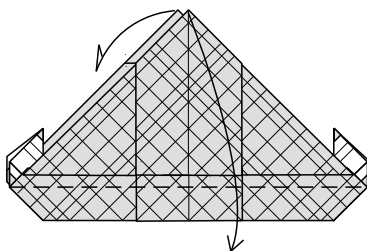

22. Valley down.

23. Valley up.

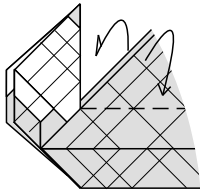

24. Valley down sides.

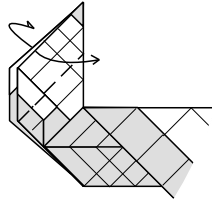

25. Wrap around top point, reversing at the bottom corners. Repeat on other side.

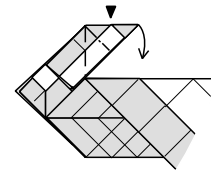

26. Squash. Repeat at other side.

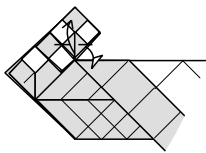

27. Flip the square. Repeat at the other side.

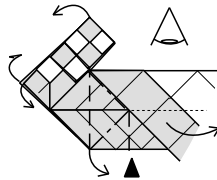

28. Spread squash the bottom, allowing the side flaps to swing outwards.

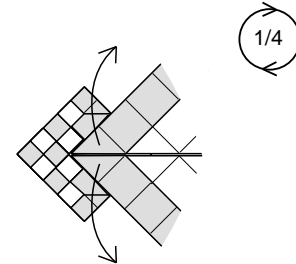

29. View from step 28. Spread apart the pleats. Rotate model.

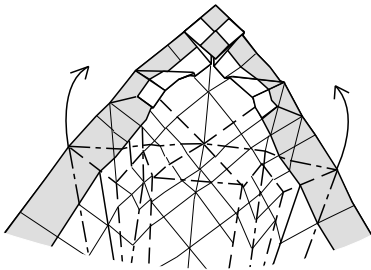

30. Reform, changing the direction of some of the folds. Form the horizontal mountain folds first. Repeat steps 29-30 at bottom.

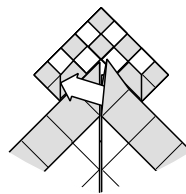

31. Pull out single layer (you will have to raise the flap slightly to do this).

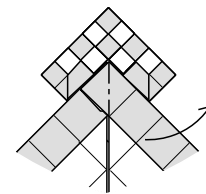

32. Open out the hem forming a squash at the top.

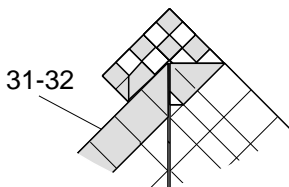

33. Repeat steps 31-32 on the remaining three hems.

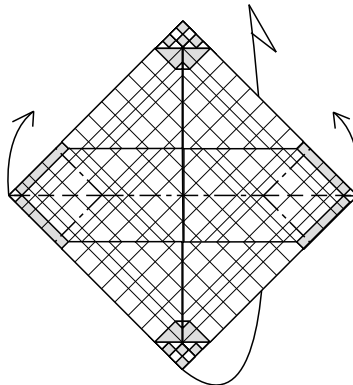

34. Mountain in half while incorporating reverse folds.

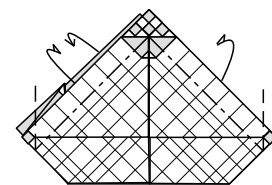

35. Swivel in the sides.

22-30

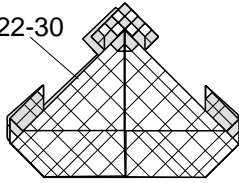

36. Repeat steps 22-30.

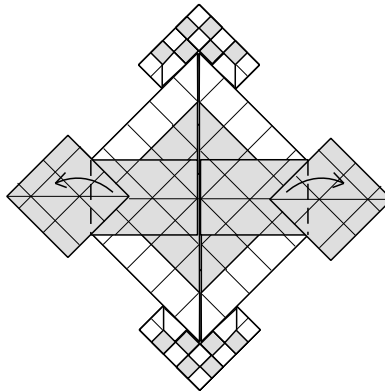

37. Valley outwards.

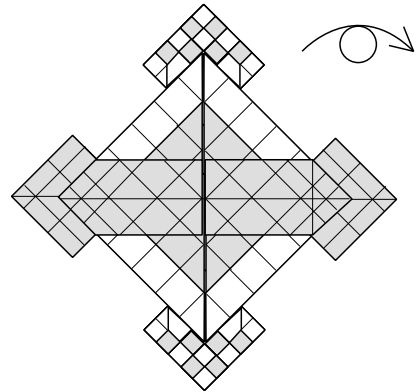

38. Turn over.

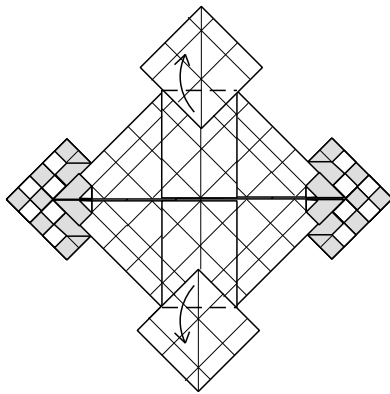

39. Valley outwards.

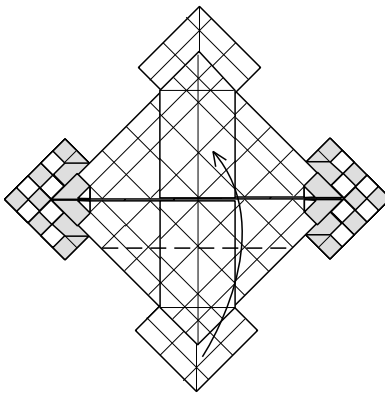

40. Valley up.

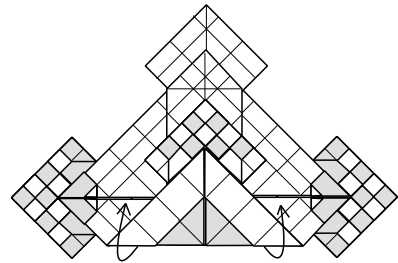

41. Wrap a single layer around at each side.

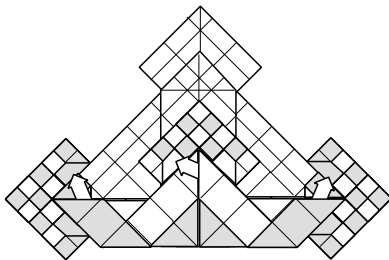

42. Pull out a single layer at the three indicated flaps.

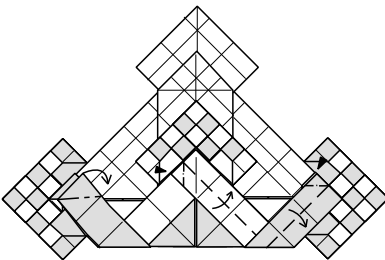

43. At the left, reverse the corner back in (you will have to raise the flap slightly). On the other side, swivel over the hem, squashing the corners.

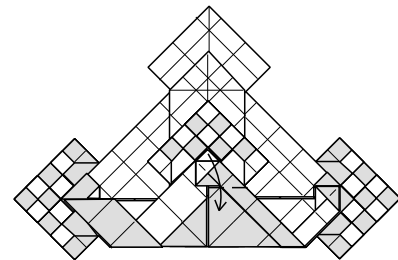

44. Swing down.

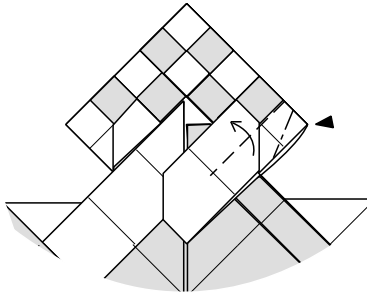

45. Spread squash the corner.
The section will not lie flat.

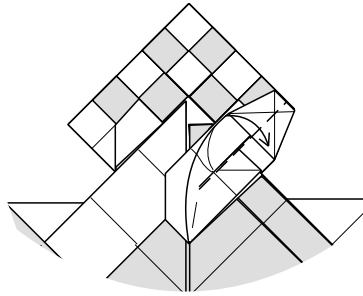

46. Close back up.

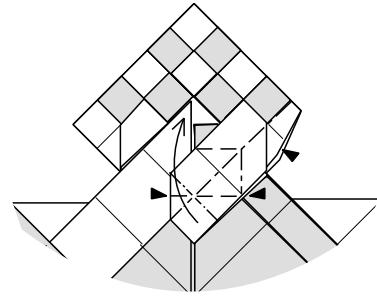

47. Closed sink the top corner
while collapsing the bottom
point and swinging it
upwards.

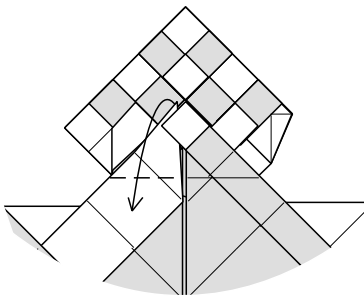

48. Swing down.

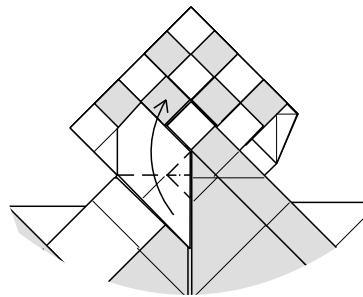

49. Valley back up while
incorporating a reverse fold.

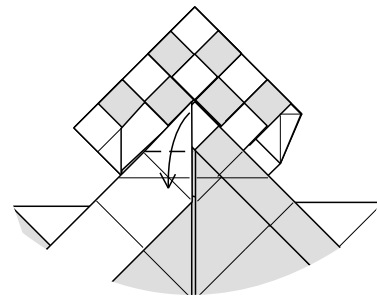

50. Valley down.

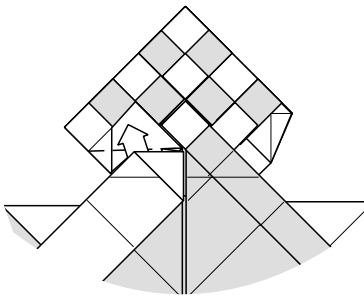

51. Unsink a single layer

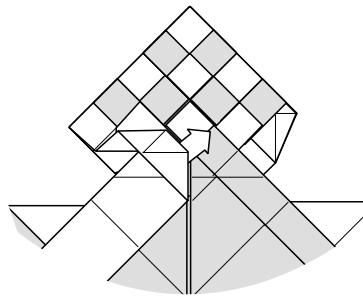

52. Open out slightly and release
a single layer.

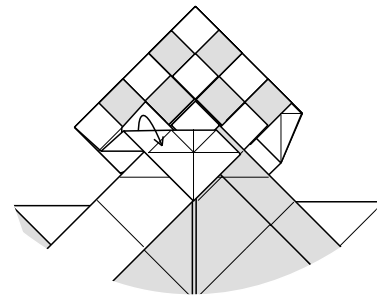

53. Wrap around a single layer.

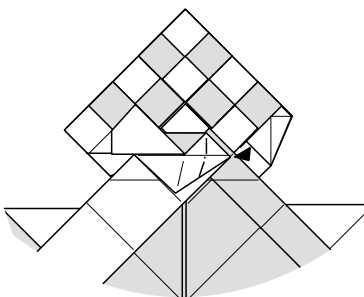

54. Reverse fold (you will have
to raise the flap slightly
to do this).

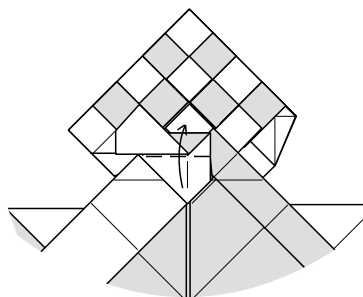

55. Swing flap up.

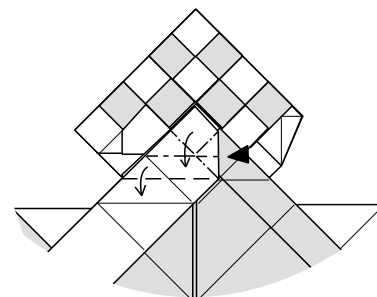

56. Collapse the flap downwards.

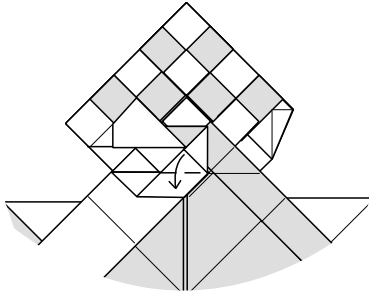

57. Swing down lightly.

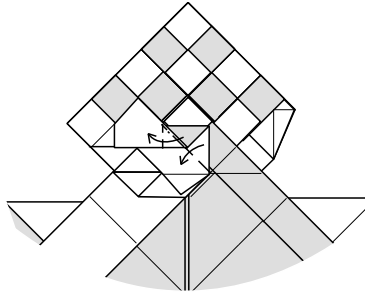

58. Swivel over.

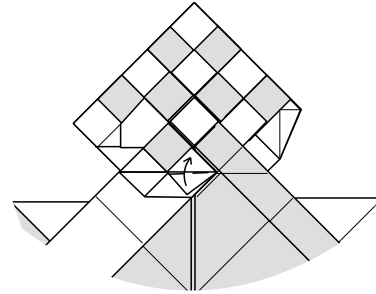

59. Swing back up.

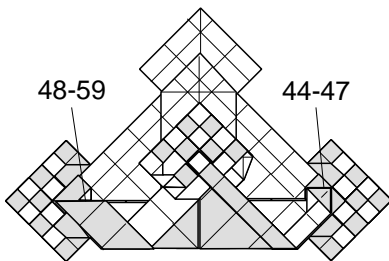

60. Repeat steps 48-59 at the left and 44-47 at the right.

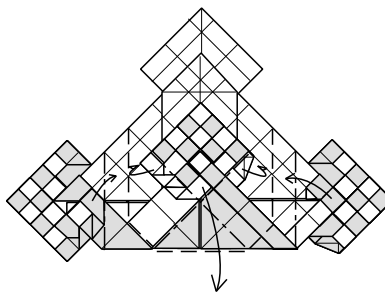

61. Crimp the side squares inwards while collapsing the center square downwards. Allow the squares to interlock.

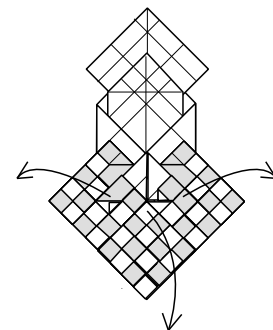

62. Open out, folding the center square out of the way.

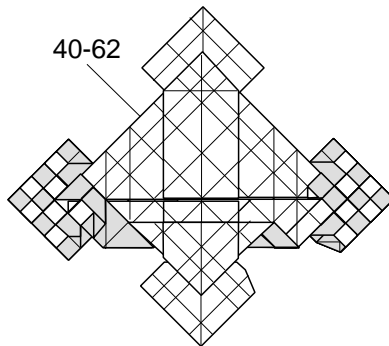

63. Repeat steps 40-62 at the top.

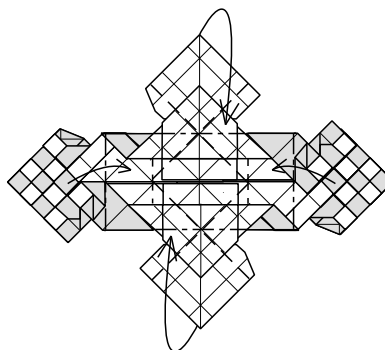

64. Collapse all of the squares inwards, using the folds from step 61. At 64 steps, this will work out to one step per square.

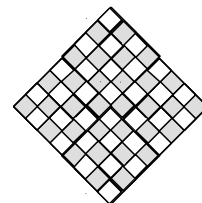

65. Completed Chess Board
©1996 Marc Kirschenbaum

This model was inspired by the successful chess boards of Stephen Casey and John Montroll. I am especially thankful to John, for sharing his trials and tribulations with this subject matter.